

## Technical Specification

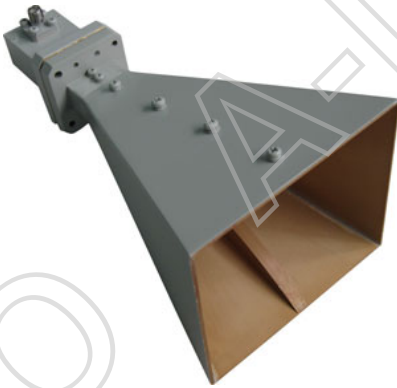

Frequency Range (GHz)	5.8 - 16.0
Gain(dB)	15 Typ.
Polarization	Linear
VSWR	2.0 Max
Cross Polarization Isolation(dB)	-30 Typ.
Waveguide(A Type)	WRD580D28
Adapter(C Type)	580DRWCAS or 580DRWCAN
Connector(C Type)	SMA-F or N-F
Size(mm)	84x71x167 (Including Adapter)
Net Weight(Kg)	0.35 Around (Including Adapter)

## Outline Drawing (Size: mm) Including Adapter

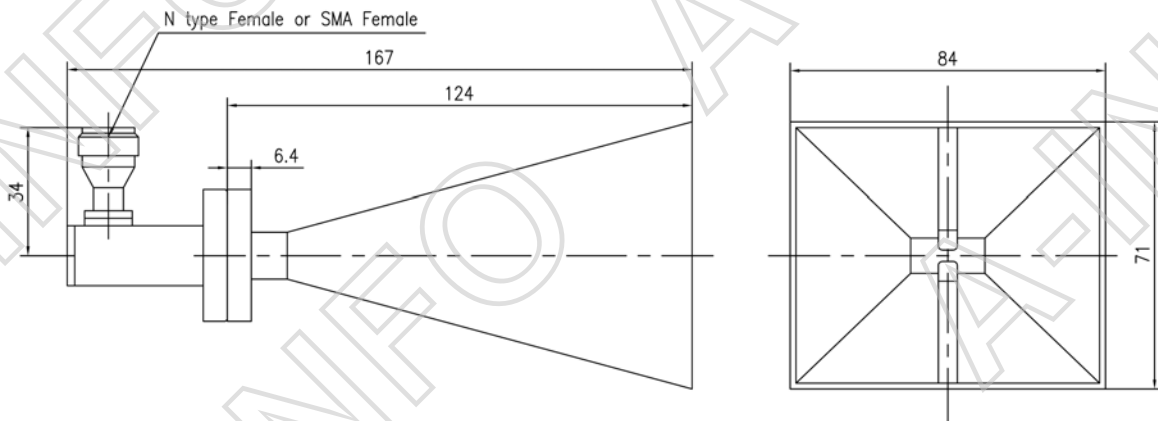

## Flange Drawing (Size: mm)

### FPWRD580D28

(With two through mounting holes and two screws holes)

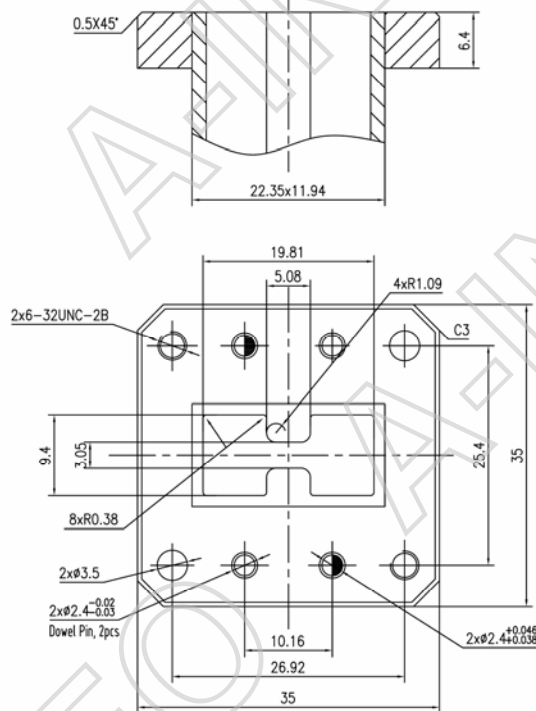

## Test Results

### 1. Gain

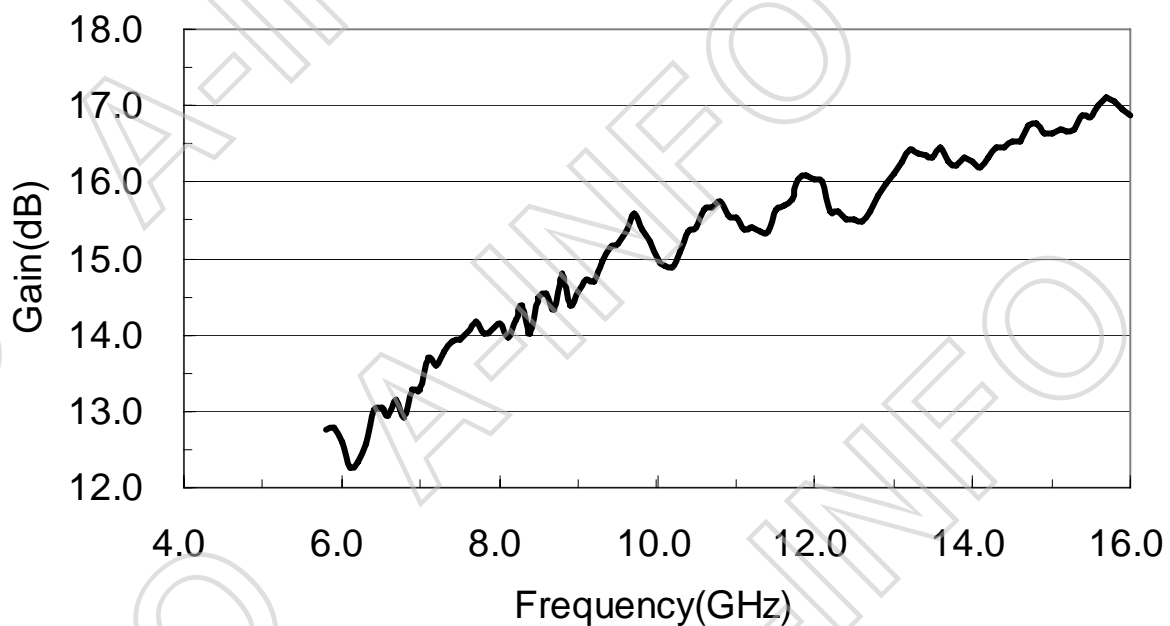

## 2. Antenna Factor

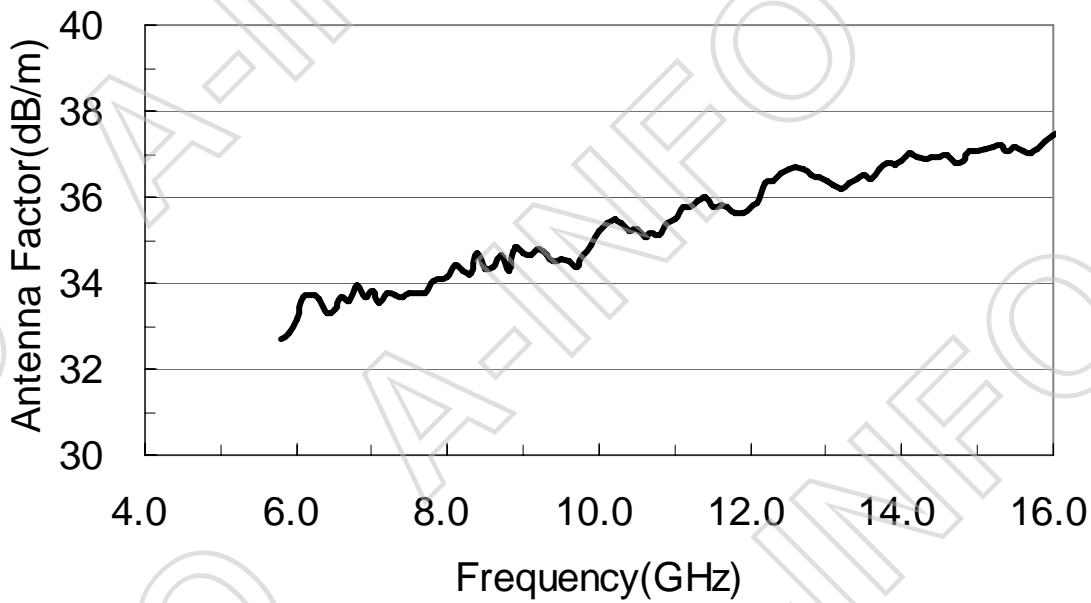

## 3. VSWR

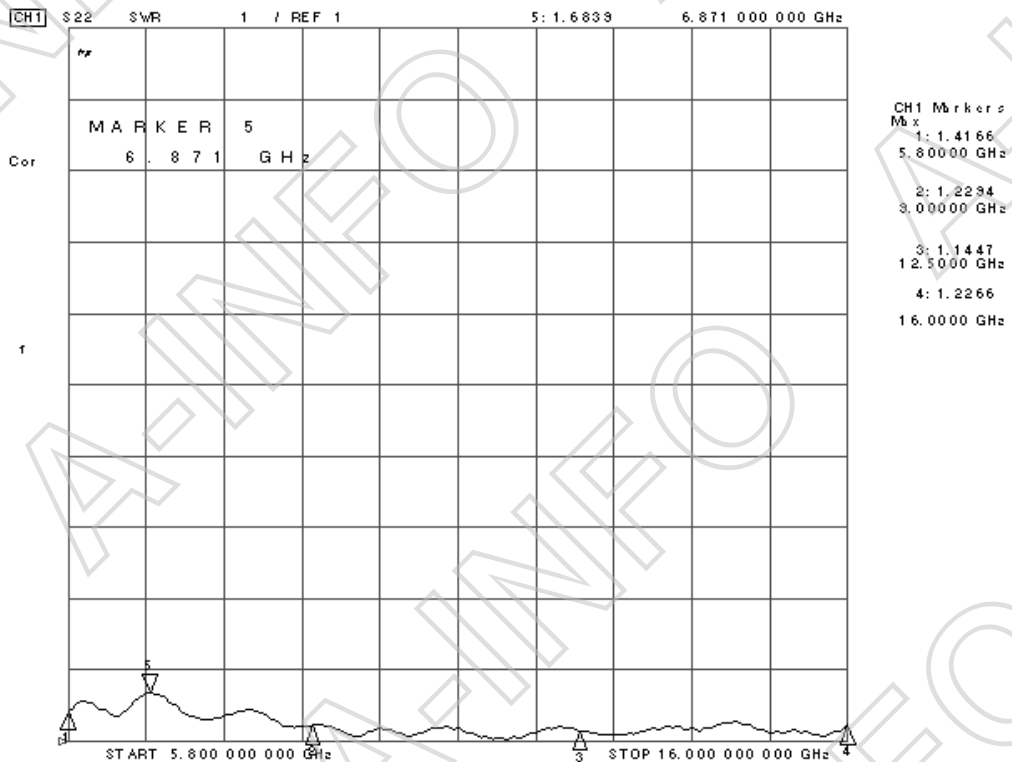

## 4. Cross Polarization Isolation

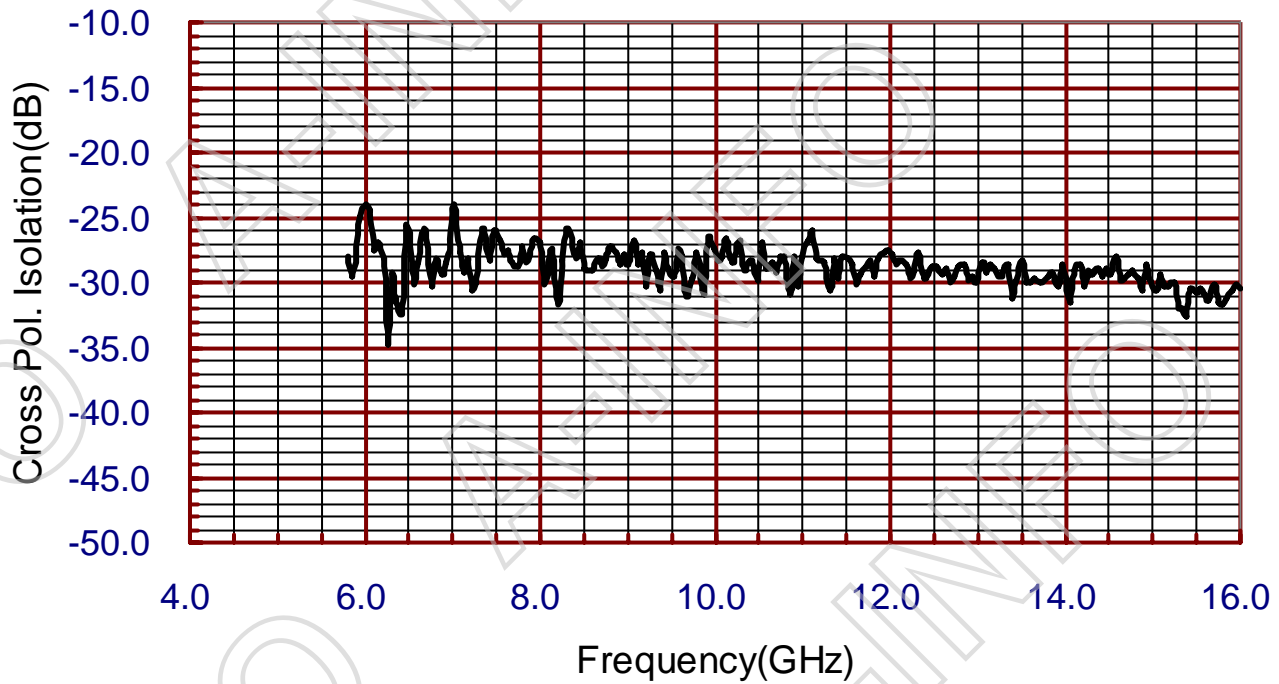

## 5. Pattern

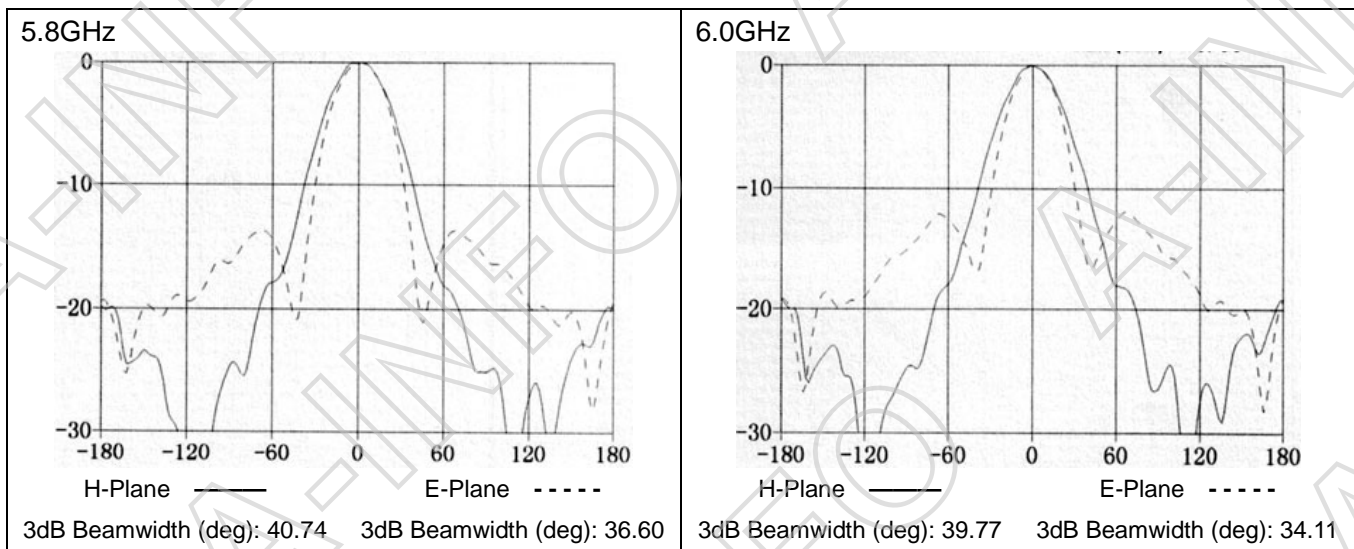

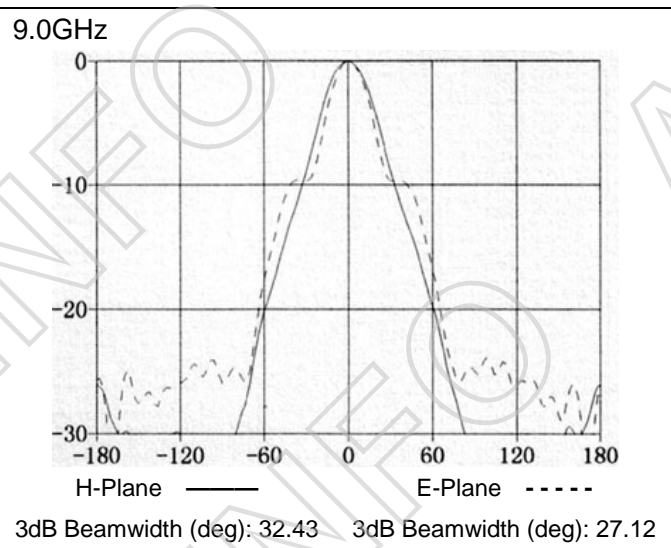
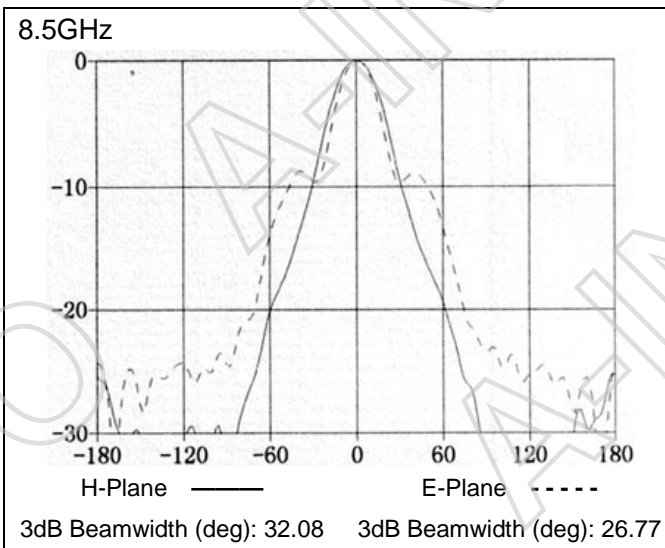
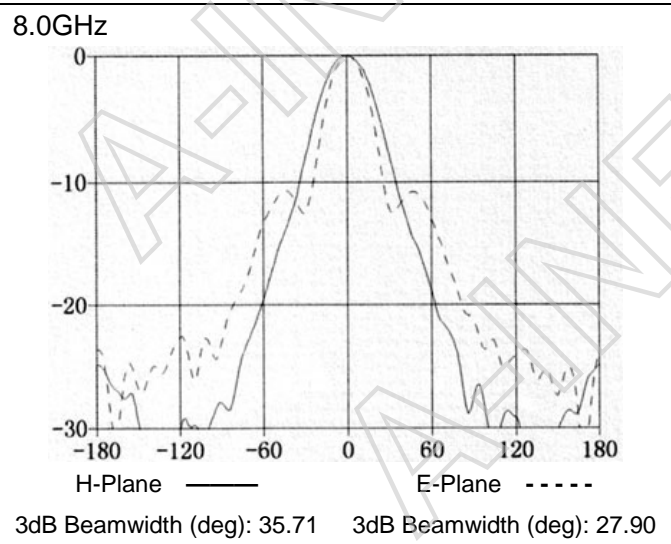
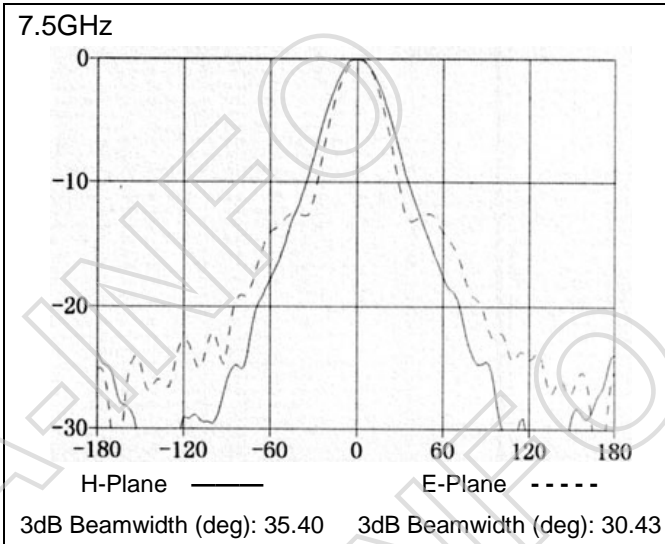
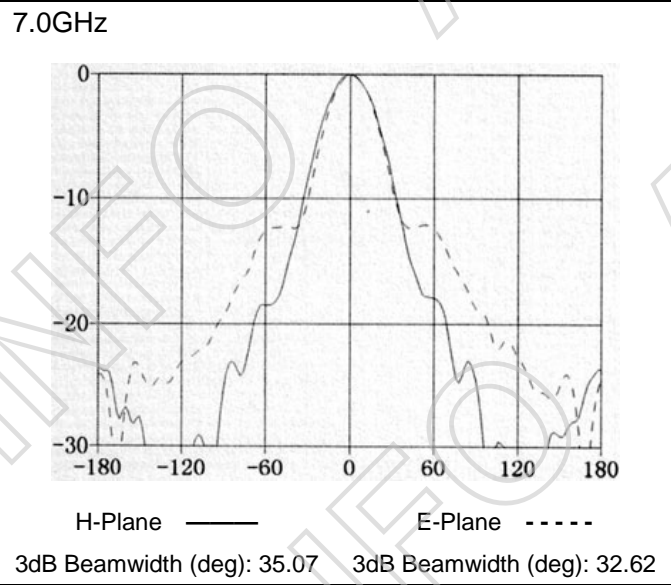
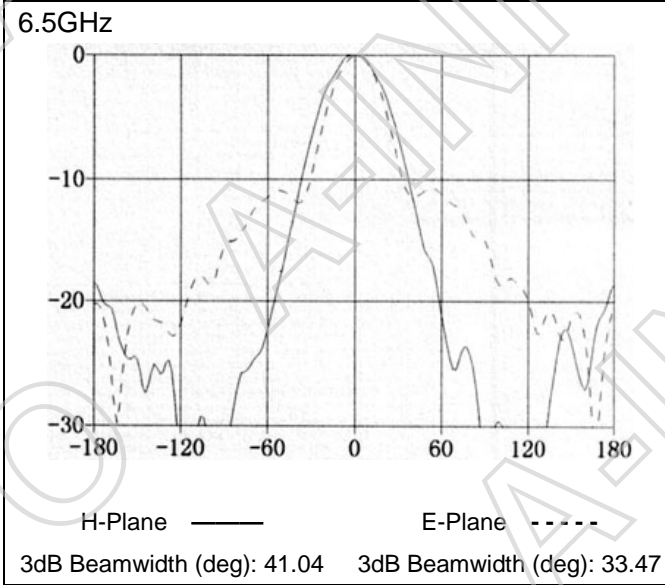

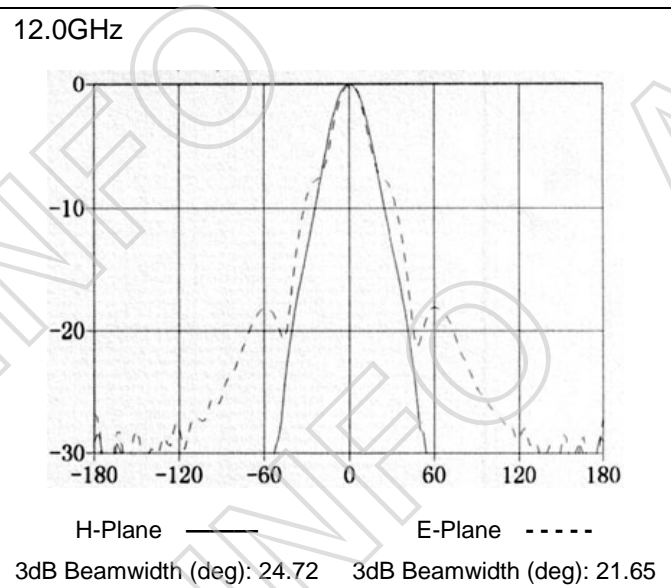
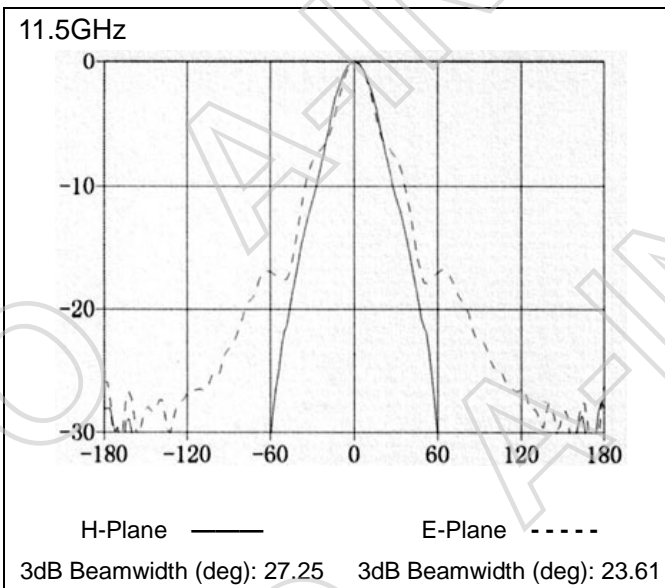
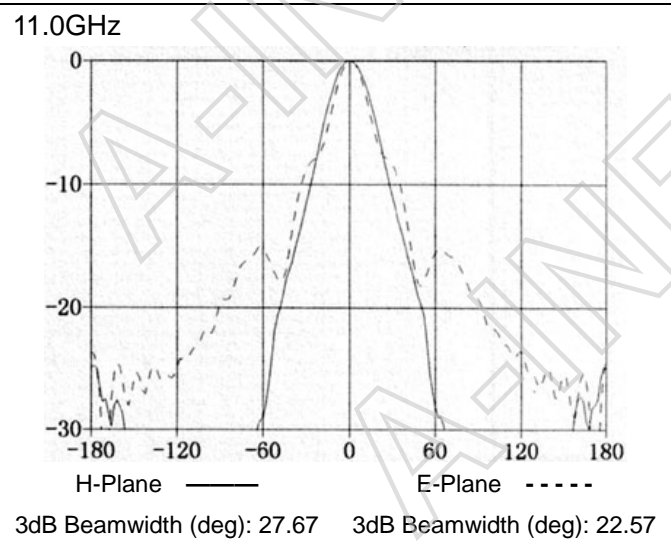
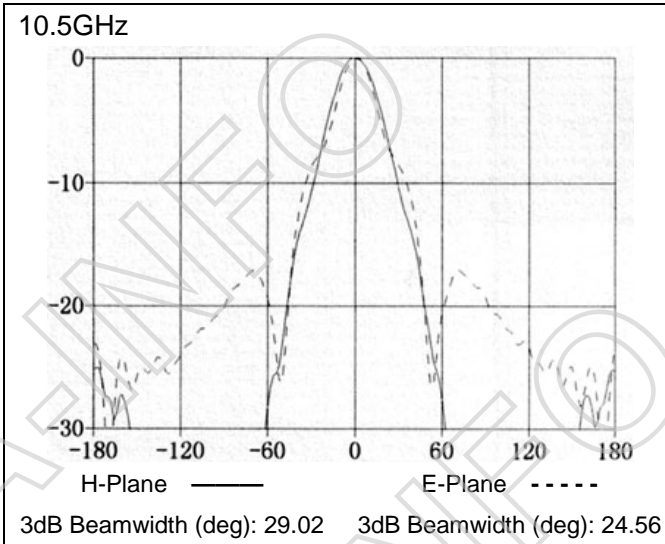
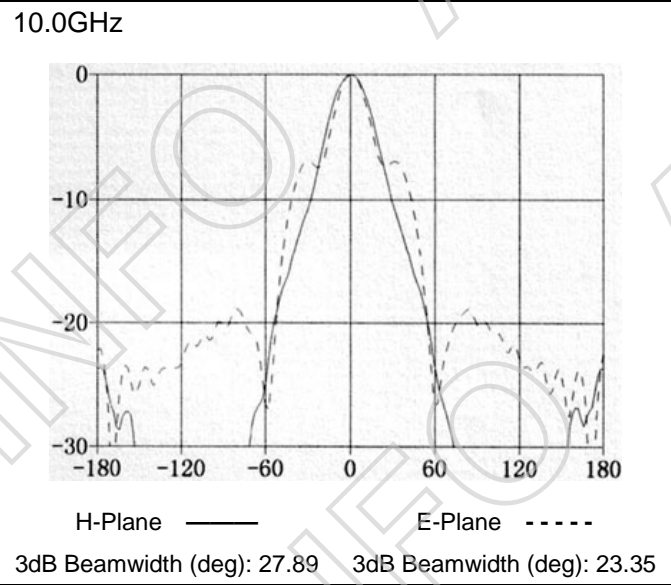
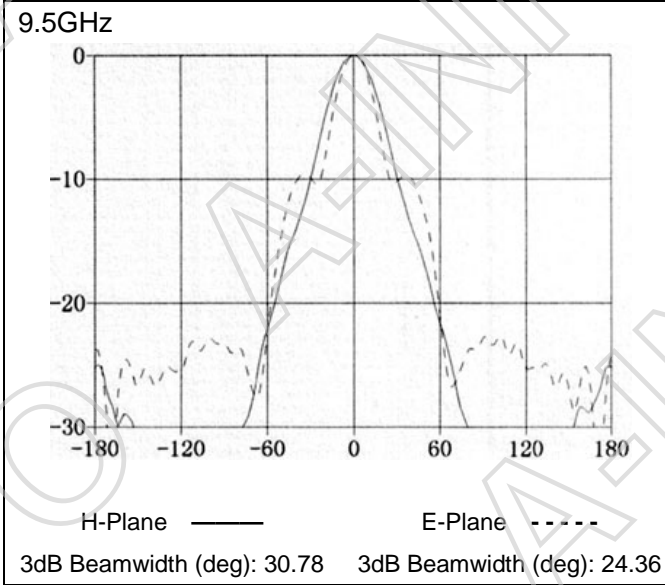

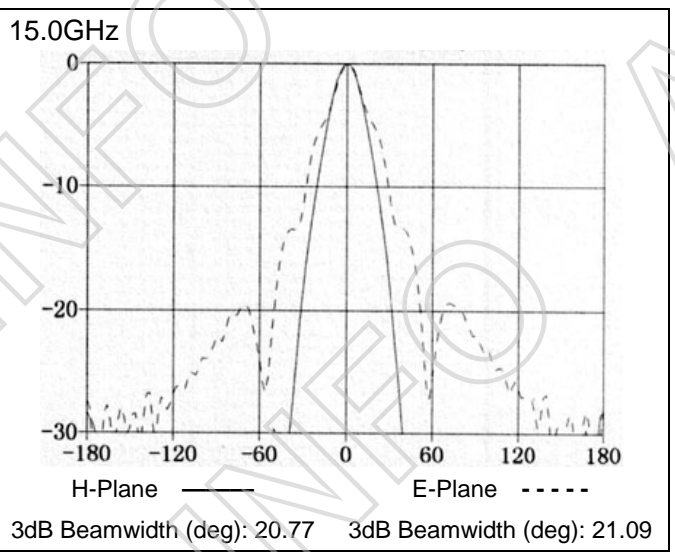
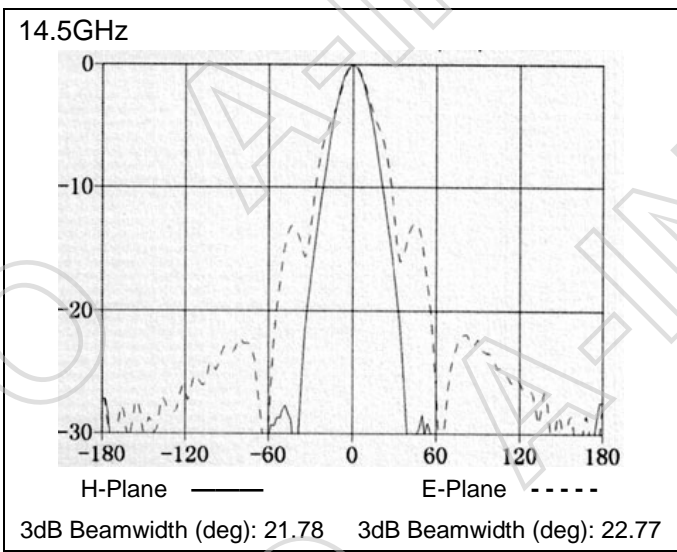
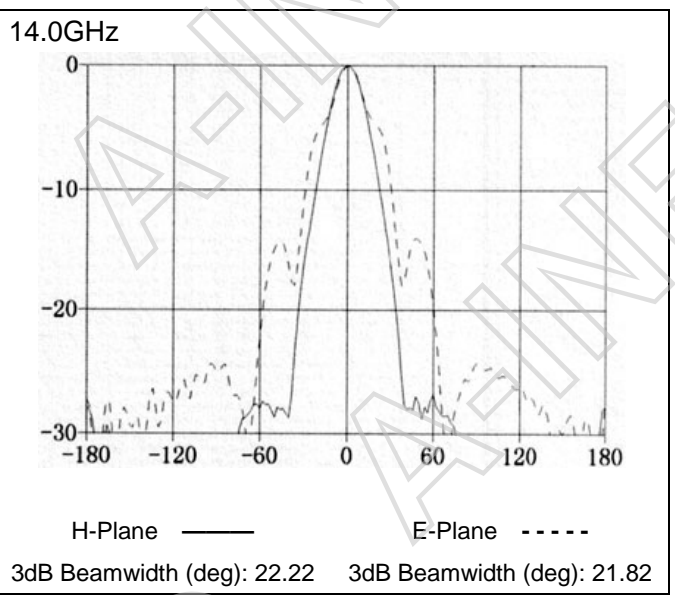
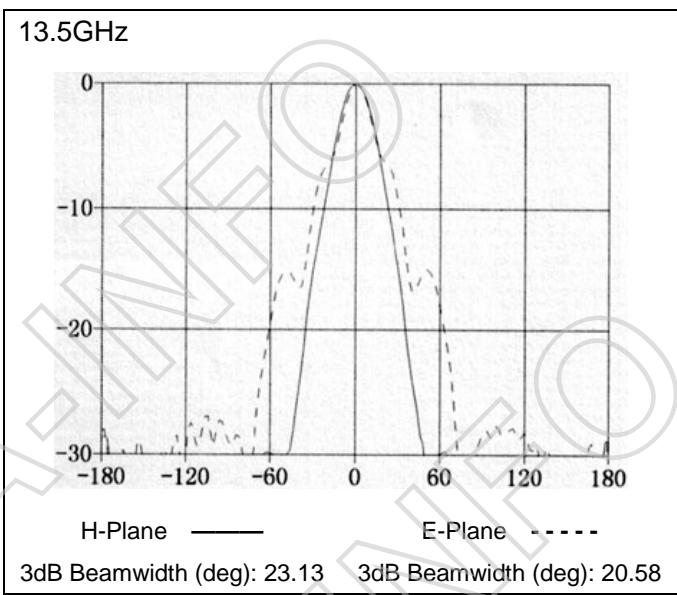
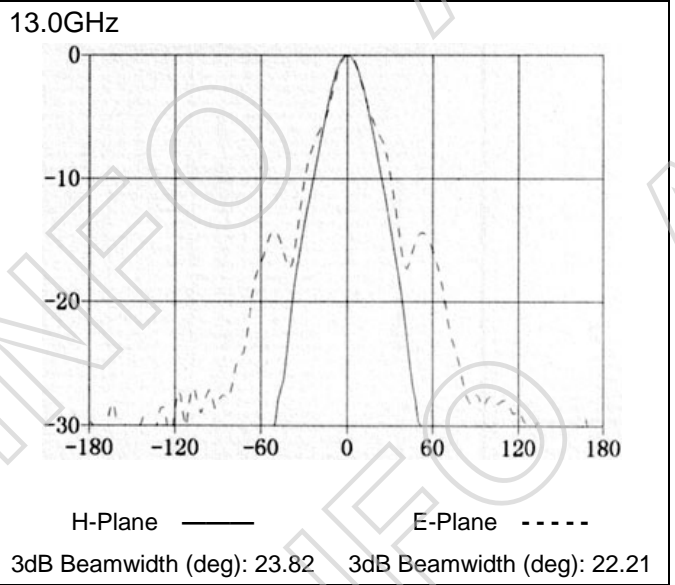
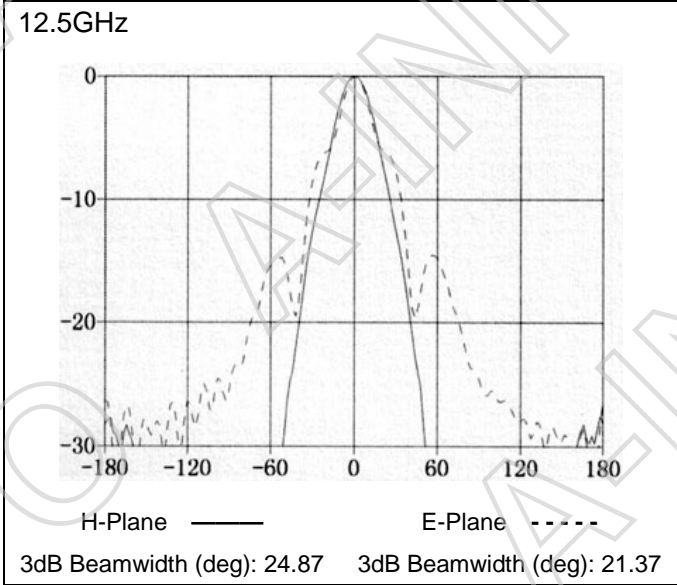

15.5GHz

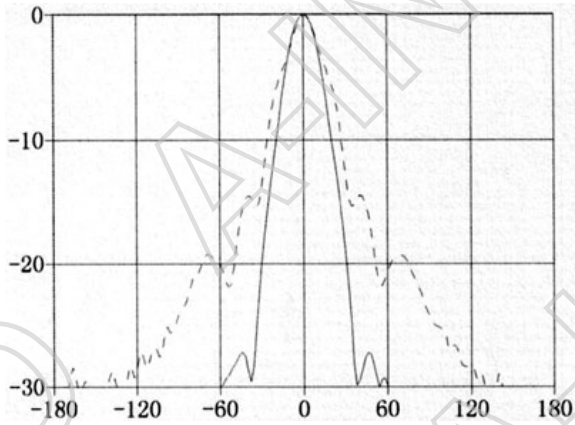

H-Plane — E-Plane - - - -

3dB Beamwidth (deg): 20.75    3dB Beamwidth (deg): 22.06

16.0GHz

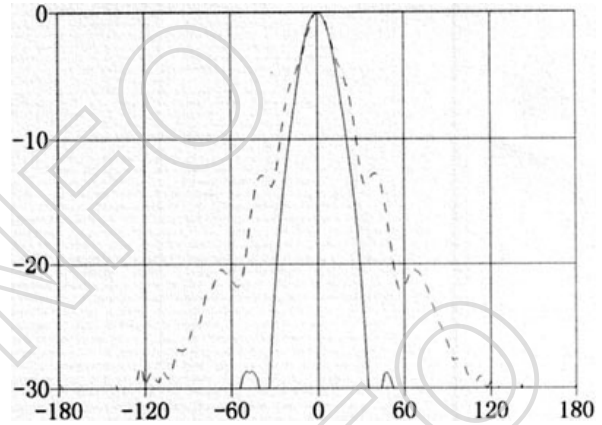

H-Plane — E-Plane - - - -

3dB Beamwidth (deg): 20.54    3dB Beamwidth (deg): 20.84